

5M HD Analog IR Turret

CVD2-25-R

Features

- Analog High Definition Universal over Coax Technology
- Sens-up Super Low Light Technology
- 1/2.8" CMOS Sensor
- Max 1944P Resolution at 12.5/20fps
- Wide Dynamic Range (WDR)
- MFZ P-Iris Lens from 2.7~13.5mm
- Smart IR™ with Intelligent Camera Sync. 80ft Range
- Smart DNR™ 3D Digital Noise Reduction
- Highlight Masking Exposure (HME)
- True Day/Night Mechanical IR Cut Filter
- Programmable Privacy Zones
- Auto Gain Control (AGC)
- Back Light Compensation (BLC)
- Dynamic Range Compressor (DRC) Reveals Low Light Detail
- Auto White Balance (AWB)
- IP67 Certified (Weather Resistant)
- OSD Control via Coax Cable using UTC



Dimension (mm)

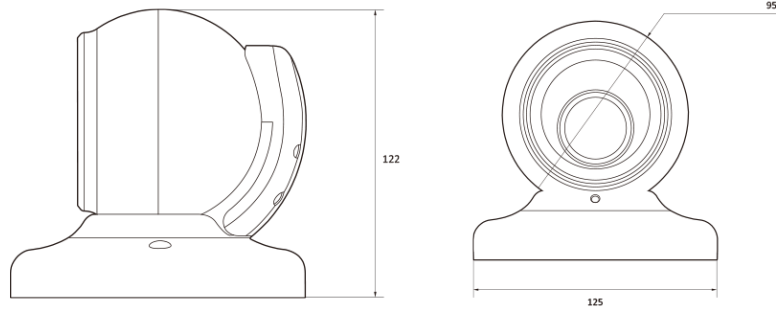

Specification

Video

Image Sensor	1/2.8" 5M CMOS
Num of Channels	1
Total Pixel	2704(H) x 2104(V)
Active Pixel	2608(H) x 1960(V)
Max Resolution	2592 x 1944
MIN. Illumination	Color(at Day) : 0.08Lux (F1.4, 30IRE) B/W(at Night) : 0 lux(With IR)
Video Output	AHD or TVI or CVI or CVBS
Only installer Video Output	No
Signal Technology	Max 5M Megapixel Universal
Synchronization	Internal
Scanning Mode	Progressive Scan

Lens

Focal Length	2.7~13.5mm
Aperture	F1.4
Lens Type	Motorized
IRIS Type	P-IRIS
Horizontal Angle	D:109 , H:85 , V:62 (Wide) D:39 , H:32 , V:24 (Tele)

Operational

Shutter Speed	1/30(25) - 1/30,000 Slow Shutter (OFF-x32)
Auto Gain Control (AGC)	Yes
Day & Night	TDN (True Day & Night)
Digital Noise Reduction	2D/3D DNR
Wide Dynamic Range (WDR)	Double Scan WDR
Dynamic Range	120dB or above
LEDs	H2IR
LED Distance	80ft
Gamma	0.5
Function	Motion Detection Privacy Zone White Balance Backlight Mirror & Flip

I/O & EVENT

Audio In / Out	No
Alarm In / Out	No
UTC Built-in	UTC

I/O & EVENT

UTP Built-in	No
--------------	----

Electrical

Power Requirement	DC12V / AC24V Dual Voltage DC12V AC24V
Power consumption	DC(LED OFF) :4.36W (363mA) DC(LED ON) : 7.6W (638mA) AC(LED OFF) :4.5W (278mA) AC(LED ON) :6.27W (456mA)





Environmental

Operating Temperature	-20°C ~ 50°C
Cold Start	No
Operating Humidity	Less than 90%(Non-Condensing)
IK Rating	IK10
IP Rating	IP67
Other Certification	FCC CE ROHS

Mechanical

Housing Model	VD2
Housing	Outdoor Turret
Material	Aluminum-Die Casting
Color	White
Dimensions (W x D x H)	125mm 122mm
Weight	0.51

Compatible Accessories

 <p>BJC11 JUNCTION BRACKET</p>	 <p>BC10 NPT</p>	 <p>GP02 Gang Bracket</p>	 <p>BJC03 Junction Bracket</p>
--	--	--	--



BW10
Wall Bracket



BC10
Ceiling Bracket

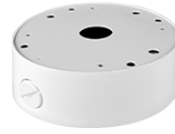

BJC09
Wall Junction Bracket



BP01
Pole Mount Bracket

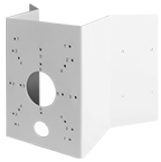

BCO01
Corner Mount Bracket